

**SET-UP AND OPERATING
INSTRUCTIONS
FOR
HYDRAULIC DRILLING
ATTACHMENTS**

Models

**NC150, NC200, NC300
M200, M300, M350
H200, H300, H350
HD400, HD500**

DRILL HOLES FAST WHERE OTHERS FAIL

P.O. Box 270, Belton, Texas 76513
(254) 939-9404 * 1-800-242-9410
Fax # (254) 939-9408

BELLTEC *Industries Inc.*

Email address sales@belltec.net

Internet Address <http://www.belltec.net>

BELLTEC INDUSTRIES, INC.
P. O. Box 270
Belton, TX 76513

LIMITED WARRANTY

*Belltec Industries, Inc., ("Belltec") warrants to the original purchaser, that each Hydraulic Digger drive, when properly installed, used, and maintained, shall be free from defects in workmanship and material as follows from date of delivery by Belltec or a Dealer or Distributer:

Models NC-150 NC-200 NC-300 for a period of 2 years

Models M-200 M-300 M-350 for a period of 4 years

Models H-200 H-300 H-350 for a period of 5 years

Models HD-400 HD-500 for a period of 4 years

Parts claimed defective must be removed from the machine at the purchaser's expense, and returned to the factory, for inspection, shipping charges prepaid, within 15 days after purchaser learns of facts upon which claim is made. Parts found defective will be promptly replaced or repaired and returned without charge.

Belltec's obligation and liability under this warranty is expressly limited to repairing or replacing at Belltec's option any part which appears to Belltec upon inspection to have been defective in material or workmanship. Replacement or repaired parts installed in the product covered by this warranty are warranted only for the remainder of the original warranty as if such parts were original components of said product.

LIMITATION OF DAMAGES: Belltec's obligation under this warranty shall not include any transportation charges, costs of installation, duty, taxes or any other charges whatsoever or any liability for direct, indirect, incidental or consequential damages or delay. Belltec's liability for any and all losses and damage to Purchaser resulting from any cause whatsoever, including negligence or breach of form of warranty, express or implied, by Belltec, alleged damage for defective goods, irrespective of whether such defects are discoverable or latent, shall in no event exceed the purchase price of the particular goods. Any improper use including operation after discovery of defective or worn parts not approved by Belltec or any alteration or repair by others in such manner as in Belltec's judgment affects the product materially and adversely shall void this warranty.

Parts worn from use or damaged, broken or bent from misuse and parts subject to normal maintenance are not covered by this warranty.

No employee, dealer, salesman, or representative is authorized to change this warranty in any way or grant any other warranty unless such change is made in writing and signed by an officer of Belltec at its home office.

THE FOREGOING WARRANTIES ARE EXCLUSIVE AND ARE IN LIEU OF ALL OTHER WARRANTIES (WHETHER WRITTEN, ORAL OR IMPLIED) INCLUDING WARRANTIES OF MERCHANTABILITY AND WARRANTY OF FITNESS FOR A PARTICULAR PURPOSE.



THIS SAFETY ALERT SYMBOL IDENTIFIES IMPORTANT SAFETY WARNING MESSAGES. CAREFULLY READ EACH WARNING MESSAGE THAT FOLLOWS. FAILURE TO UNDERSTAND AND OBEY A SAFETY WARNING, OR RECOGNIZE A SAFETY HAZARD, COULD RESULT IN AN INJURY OR DEATH TO YOU OR OTHERS AROUND YOU. THE OPERATOR IS ULTIMATELY RESPONSIBLE FOR THE SAFETY OF HIMSELF, AS WELL AS OTHERS, IN THE OPERATING AREA OF THE POST HOLE DIGGER.



SAFETY INSTRUCTIONS - READ CAREFULLY



The use of this equipment is subject to certain hazards, which cannot be protected against by mechanical means or product design. All operators of this equipment must read and understand this entire manual, paying particular attention to safety and operating instructions, prior to using the Belltec hydraulic earth drill. If there is something in this manual you do not understand, ask your supervisor to explain it to you. Failure to observe these safety precautions can result in death or serious injury or serious equipment damage.

Do not take chances - be a careful operator. Read this manual thoroughly before attempting to operate the earth drill. Working with unfamiliar equipment can cause accidents. If after thoroughly reading this manual, you have any questions regarding safety or understanding the intended uses and the limitations of your Belltec Hydraulic Earth Drill, contact the Belltec office or your authorized dealer. We will be more than happy to assist you in the proper use

of this machine. **Be safety conscious.**

The safety of the operator is one of the prime considerations of Belltec engineers. Shielding, adjustments, and other safety features were built into the machine wherever possible. The owner, operator, and person who is directly responsible for the operation of the digger must accept his responsibility for safe operation. With your cooperation, by not taking risks, and understanding the manual in full, to know how to be careful, accidents can be prevented. **If the person who will operate this machine does not read or understand English, it is the owner's responsibility to translate or provide an interpreter.**

You will find in this manual notes, warnings and cautions. This does not mean that the digger is dangerous. Nor does it mean that they should be taken lightly. You must exercise the utmost care and caution in use of the digger, and realize that it is a powerful machine that can cause serious injury or death if improperly used. Hitching and removing the digger, along with digging with other workmen present are the times you need to be extremely cautious.



ACCIDENTS ARE PREVENTABLE WITH YOUR HELP



SAFETY PRECAUTIONS











THIS MANUAL MUST BE READ AND UNDERSTOOD IN ITS ENTIRETY BEFORE ATTEMPTING ANY ASSEMBLING, OPERATION, INSTALLATION, MAINTAINING OR REPAIRING OF THE DIGGER. STRICTLY OBSERVE THE NOTES, CAUTIONS AND WARNINGS NOTED THROUGHOUT THIS MANUAL.



**OPERATE DIGGER ONLY FROM TRACTOR SEAT.
KEEP ALL OTHERS AT LEAST 10 FEET AWAY.**



A careful operator is the best protection against accidents. Most accidents involving operators of equipment are listed below

- | | |
|--|--|
| <p>1)  Only the operator should be allowed on the machinery when the digger is in operation. Make sure they are instructed and capable of safe operation. Carefully supervise inexperienced operators. Never allow children to operate the digger.</p> <p>2) Learn how to operate this machine in a safe, open area before operating in tight quarters or in conjunction with other equipment or people.</p> <p>3)  All bystanders should be kept a minimum of 10 feet (3 meters) away from working area of the earth drill. Never operate the earth drill controls from the ground. Always operate the vehicle and earth drill from the correct operating position.</p> <p>4)  Always wear an OSHA approved hard hat and safety eye protection when operating or servicing this equipment. Do not wear loose fitting clothing, flopping cuffs, dangling neckties and scarves, or rings and wrist watches that can catch moving parts.</p> <p>5)  An operator must not use drugs or alcohol which can change his alertness or coordination. An operator taking prescription or over-the-counter drugs should seek medical advice on whether or not he can safely operate equipment.</p> <p>6)  Always locate underground electrical wires, telephone cables, gas, water and sewer lines before digging. Maintain safe clearance and avoid contact with any underground or overhead utility lines or electrically charged conductors.</p> <p>7)  Never alter or remove any safety decals or shields. Replace all missing or damaged safety decals or safety shields. Check this manual for location of these items and replace immediately if damaged or illegible.</p> | <p>8)  Whenever changing or installing this or other attachments, make sure all connections are securely fastened.</p> <p>9)  Avoid steep hillside operation which could cause the vehicle to overturn. Consult your vehicle operator's and safety manuals for maximum incline allowable.</p> <p>10)  Travel only with the earth drill in a safe transport position to prevent uncontrolled movement. Drive slowly over rough ground and on slopes. Tether earth drill with a chain, if necessary to prevent uncontrolled swinging of earth drill when moving from hole to hole. Remove earth drill from vehicle when transporting to and from job site.</p> <p>11) Before exiting vehicle, lower earth drill to ground, turn off vehicle engine and lock vehicle brakes.</p> <p>12)  Do not work on or make any adjustments to the tractor or digger while either is in operation. Turn off tractor engine, lower digger to the ground and operate digger control levers to relieve residual hydraulic pressure before adjustments or repairs are made, or when leaving the tractor. Do not leave the digger unattended with the auger raised. Always lower it to the ground.</p> <p>13)  Never check a pressurized system for leaks with your bare hand.. Oil escaping from pinhole leaks under pressure can penetrate skin and could cause serious infection. Hold a piece of cardboard up next to suspected leaks and wear a face shield or safety eye protection. If any fluid is injected into the skin, it must be removed within a few hours by doctor familiar with this type of injury.</p> |
|--|--|



- 14) Before disconnecting hydraulic lines or fittings be sure to relieve all pressure by cycling all hydraulic controls after shutdown. Remember hydraulic systems are under pressure whenever the engine is running and may hold pressure after shutdown. Before applying pressure to the system make sure all connections are tight and that there is no damage to lines, fittings and hoses.



- 15) Flow and pressure gauges, fittings and hoses must have a continuous operating pressure rating of at least 25% higher than highest pressures of this system.



- 16) Never adjust a relief valve for a pressure higher than recommended by vehicle manufacturer.

- 17) When digging rocky soil, always wear safety glasses.



- 18) Always wear safety glasses and appropriate protective gear when working on the digger, particularly when driving pins or teeth with a hammer.

- 19) Never perform any work on an earth drill unless you are authorized - and qualified - to do so. Always read the operator service manual(s) before any repair is made. After completing maintenance or repair, check for correct functioning of the earth drill. If not functioning properly always tag "DO NOT OPERATE" until all problems are

corrected

- 20) Check the machine frequently to be sure there are no loose bolts. Be sure to immediately tighten any loose nuts with the proper tools.

- 21) Before digging or otherwise operating the machine, you should carefully inspect the area to be worked, looking for and noting all gullies, or ditches, etc. and removing any posts, trash, wire, and other obstacles or potential hazards.

- 22) This manual covers the safe use, installation, operation and service instructions for the earth drill only. Always read the operating and safety manuals prepared for your vehicle and any other attachments before using them

- 23) Please remember that it is IMPORTANT that you read and heed the safety signs (decals) on the digger, and the safety rules set forth above. Clean or replace all safety signs (decals) if they cannot be clearly read. They are for your own safety as well as the safety of others.



We cannot be there to make sure that you follow these rules of safe operation. The safe use of this machine is strictly up to you, the operator.

HYDRAULIC SYSTEM HOOK-UP INSTRUCTIONS

- 1) Once the installation instructions are complete you are now ready to make the hydraulic connections necessary to operate your earth drill. READ AND UNDERSTAND SAFETY INFORMATION PRIOR TO MAKING HYDRAULIC CONNECTIONS.
- 2) Your equipment dealer is in the best position to advise you the best location on your machine to make the hydraulic connections to power your earth drill drive unit. The list below shows the most common places to “tap” into the hydraulic systems on various types on machines.

a. SKID STEER LOADERS

- i. Auxiliary hydraulic outlets.

b. BACKHOES AND EXCAVATORS **

- i. Auxiliary hydraulic outlets or bucket curl cylinder circuit.

c. WHEEL LOADERS AND TRACTOR LOADERS **

- i. Auxiliary hydraulic outlets or bucket tilt (dump) cylinder circuit.

d. TRACTOR 3-POINT HITCHES

- i. Remote (auxiliary) hydraulic outlets.

e. FORKLIFTS

- i. Auxiliary hydraulic outlets or side shift circuit
- ii.

3)

**** Note:** Some auxiliary outlets on these vehicles are one way circuits only and turn on flow abruptly with such force that is can cause damage to hydraulic motors and other parts of system and will not reverse Earth Drill to free the auger if it becomes lodged. Check this before installing on one of these outlets.

- 4) Determine length of hydraulic hoses required to plumb the drive unit into the place on your machine where you'll be “tapping” into the hydraulics. Be sure the two hydraulic hoses are long enough to perform at the full range of the earth drill's operating capacity.
- 5) Fittings on the other end of each hydraulic hose should match the threads on hydraulic quick couplers to be used.
- 6) WARNING! HOSES AND FITTINGS MUST HAVE A CONTINUOUS OPERATING PRESSURE RATING OF AT LEAST 25% HIGHER THAN HIGHEST PRESSURES OF THE SYSTEM YOU ARE “TAPPING” INTO.
- 7) Once all hydraulic connections have been made and checked for leaks and proper hose lengths, you are now ready to operate your earth drill.
- 8) READ AND UNDERSTAND OPERATING INSTRUCTIONS AND SAFETY INFORMATION PRIOR TO OPERATING YOUR EARTH DRILL

OPERATING INSTRUCTIONS

- 1) After all installation instructions have been completed, safety information read and understood and the rest of this operator's manual has been reviewed, your Belltec Hydraulic Drill is now ready for use.
- 2) With the auger raised off the ground and the vehicle engine set at a low RPM, activate the earth drill control valve to determine position control valve lever must be in to turn auger in a forward (clockwise) rotation. This is the "digging" position.
- 3) Before beginning to dig, experiment with auger speed to determine a suitable auger RPM. Generally in light and sandy soils a high RPM is desirable. In hard, rocky or frozen soils a slower RPM is desirable. To increase auger RPM, increase vehicle engine RPM. To decrease auger RPM, decrease vehicle engine RPM.
- 4) Return earth drill control valve to neutral position to stop the auger. Lower the auger to the ground so that only the center point penetrates the ground about 2" (51mm).
- 5) Activate the earth drill control valve so auger is turning in a forward (clockwise) rotation. Use only enough down pressure to assure positive penetration of auger into the ground. Ease up on down pressure if auger rotation slows down drastically or stalls. Excessive down pressure will cause the auger to stall frequently.
- 6) When the auger has penetrated the ground about 24" (610mm), raise the auger from the hole to clean the dirt out. Repeat this procedure until the desired hole depth is obtained.
- 7) Once required hole depth is reached, allow the auger to turn a few seconds at this depth to clean the hole.
- 8) Return the earth drill control valve to the neutral position to stop the rotation of the auger. Raise the auger out of the hole, move away from the hole, then activate the earth drill control valve to spin the loose soil off of the auger.
- 9) NOTE: Do not reverse the auger rotation to remove from the hole as loose soil on the auger flights will fall back into the hole.
- 10) If necessary, repeat steps 7 & 8 to obtain a cleaner hole.
- 11) In some soil conditions or when excessive down pressure is applied, auger may "screw" itself into the ground and become stuck causing earth drill to stall. If this happens, reverse the auger rotation (counter-clockwise) by moving the control valve lever to the reverse position and slowly raise the auger. Once unstuck, return the control valve lever to the forward rotation position and continue digging.
- 12) If the auger becomes lodged under rocks, roots or other large obstructions, do not attempt to raise the auger out of the ground. See step 11 for proper procedure to relieve the auger.
- 13) If the auger hits a large obstruction the vehicle hydraulic relief valve will open and bypass the oil to stall (stop) the auger. This does not damage the unit in anyway but serves as a protection device. Whenever this happens simply reverse the auger rotation and raise the auger. Once unstuck you can continue digging.
- 14) Avoid excessive side loading to earth drill which can cause drive unit or auger damage.
- 15) Keep auger teeth and points in good condition. Check frequently and always keep spares on hand so they can be replaced as wear is detected to avoid damage to tooth holders and auger flighting.

MAINTENANCE INSTRUCTIONS

CLEAN HYDRAULIC OIL IS ESSENTIAL! 80% of all hydraulic component failures are caused by contamination of the hydraulic oil. Always keep all dirt and other contaminants from entering hydraulic system during disconnect and connect operations. Always use dust caps and plugs on all quick disconnects when not in use. Tightly cap all hydraulic openings to hold oil in and keep dirt and other contaminants from entering hydraulic system.

CHECK HYDRAULIC OIL DAILY FOR CONTAMINATION. If contamination is present, determine the source of the contamination and correct the problem.

INSPECT ALL HYDRAULIC HOSE ASSEMBLIES DAILY. Replacement of hoses before failure will prevent loss of hydraulic oil, time consuming “bleeding” of the system, hydraulic oil cavitation. It will also reduce the chance of personal injury caused by hydraulic fluid.

INSPECT ALL HYDRAULIC HOSE ASSEMBLIES DAILY for cracked and brittle covers caused by excessive heat. Reduced viscosity of hydraulic oil occurs at higher operating temperatures and causes a breakdown of fluid additives such as wear inhibitors. Excessive heat will cause higher internal leakage in drive unit motor, which will make the drive unit less efficient. It can also cause seals in the drive unit motor to become brittle and crack.

CHECK AUGER DAILY for loose, worn or broken cutting teeth and points. Worn teeth or points can drastically affect auger penetration and greatly reduce auger life expectancy. Always keep spare teeth and points on hand. Some digging conditions may require checking teeth and points at more frequent intervals.

CHECK DRIVE UNIT AND ALL ACCESSORIES DAILY for loose, bent, cracked or worn bolts and fasteners. Always use grade 5 or harder replacement bolts. Always use lock washers with standard hex nuts or self-locking nuts.

CHECK DRIVE UNIT OUTPUT SHAFT DAILY for bends, cracks, breaks or wear.

The Planetary reduction gearbox has been filled with lubricant at the factory. If leakage of oil is observed the seal should be examined for damage or wear, and replaced if necessary. Inspect gearbox for any other damage, which could be causing leakage of oil, and if necessary repair and refill with lubricant. When reassembled, fill API-GL-5 No. 80 or 90.

Model	Amount of oil needed
NC150, NC200, NC300	13.5 ounces
M200, M300, M350	27.0 ounces
H200, H300, H350	27.0 ounces
HD400, HD500	84.5 ounces

WHEN STORING DRIVE UNIT for any length of time be sure drive unit motor and hoses are full of clean oil. Be sure planetary gear reduction is full (to the recommended capacity for each model as outlined in #9) of clean lubricant.

Drive unit output shaft, inside of auger collar, variable auger extension collar and all connecting pins should be coated liberally with grease to prevent rust and reduce wear.

Once paint has been worn off of auger, coat liberally with grease, as required, to prevent rusting.

TROUBLESHOOTING CHECK LIST

Any hydraulic tool will perform only as well as the hydraulic system supplying it. Earth Drill Drive Unit speed (RPM) is dependent upon the system pump output in gallons (liters) torque (power) is dependent upon the relief valve pressure setting-PSI (kg/cm²).

If your Belltec Hydraulic Earth Drill does not appear to have enough speed or power, use the following checklist to solve the problem.

SLOW SPEED (rpm) OR INSUFFICIENT DIGGING POWER.

Check pressure relief valve setting (PSI) or (kg/cm²) and hydraulic pump output (GPM) (lpm) by installing a combination flow and pressure gauge in the line supplying the drive with oil. Gauge must be installed beyond all valves and quick disconnects in order to get a true reading at the drive unit. It is imperative that the flow meter gauge be monitored closely as the digging operation progresses. The hydraulic system flow (GPM) (lpm) should remain the same and not drop off until the stall pressure (PSI) (kg/cm²) is achieved. If readings are not up to the vehicle manufacturers specifications, check for faulty relief valve and adjust or replace as required. A worn, damaged or insufficient hydraulic pump may also be a possible cause.

Are there any hydraulic line restrictions? Smaller than recommended valve and hose sizes, dirty or clogged filters, and dirty or faulty quick disconnects are examples of line restrictions that will affect drive unit performance.

Check auger and teeth for excessive wear. A worn or tapered auger or worn cutting teeth and points will drastically reduce the augers ability to penetrate the ground.

EXCESSIVE OIL HEATING

Line restrictions (see #1B), insufficient reservoir size to pump output ratio, oil passing over relief valve frequently, low oil level in reservoir, and dirty oil are all conditions which will cause oil to overheat. If oil is heating excessively, check for these conditions and remedy the situation. Excessively hot oil will greatly reduce the drive unit performance, as well as damage seals, hoses and other hydraulic system components.

OIL LEAKS

Check hydraulic motor seals and replace as necessary.

Check planetary gear reduction seals and gaskets and replace as necessary.

Check all hoses and fittings and tighten or replace as necessary.

If the above trouble-shooting checklist does not resolve your problem please contact our service department as follows:

[THIS PAGE INTENTIONALLY BLANK]

**PARTS BOOK
FOR
HYDRAULIC EARTH DRILLS**

Models

NC150, NC200, NC300

M200, M300, M350

H200, H300, H350

HD400, HD500

DECALS



The above safety sign is located near the bottom of the hydraulic drive housing. If damaged or missing order a new "DANGER" decal. We will gladly send a new one at no charge.



H200, H300, AND H350

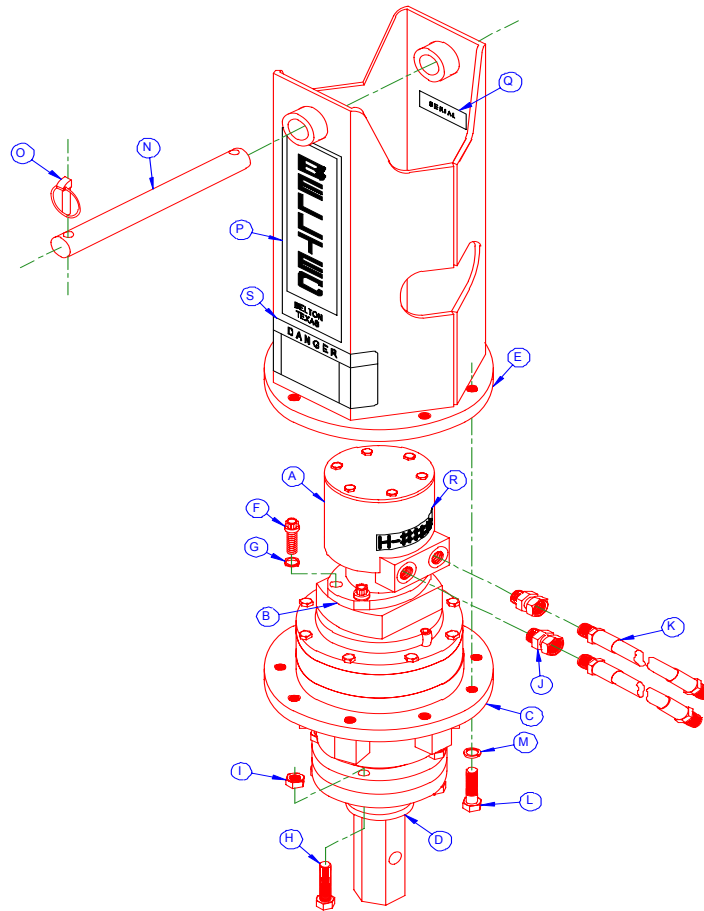

Item	Part No	Description	Quantity
A	112500	H200 HYDRAULIC MOTOR	SERIAL # 4700..... 1
	112600	H300 HYDRAULIC MOTOR	SERIAL # 4700..... 1
	112601	H350 HYDRAULIC MOTOR	SERIAL # 4550..... 1
B	111324	O-RING (NOT SHOWN)	1
C	112475	PLANETARY	1
D	113312	OUTPUT SHAFT	1
E	113222	HOUSING	1
F	HCS050150Z12	1/2"-13X 1 1/2" 12 PT BOLT	4
G	HLW050Z	1/2" LOCKWASHER	4
H	HCS05622255Z	9/16"-12 X 2 1/4" BOLT	5
I	HLN0562T	9/16"-12 LOCK NUT	5
J	111337	10 MB 8FPX ADAPTOR	2
K	111315	108" HOSE	2
L	HCS05622005Z	9/16"-18 X 2" BOLT	6
M	HLW056Z	9/16" LOCKWASHER	6
N	113206	PIN	1
O	HLP044	7/16" LYNCH PIN	2
P	111757	BELLTEC DECAL	2
Q	111766	H-DRIVE NAME DECAL	1
S	111758	WARNING DECAL	2